



Manufacturer of Valves

**PRODUCTION
PROGRAM**

**BALL VALVES
CHECK VALVES
GATE VALVES
GLOBE VALVES
PLUG VALVES
STRAINERS
OILFIELD PRODUCTS**

ASME

BS

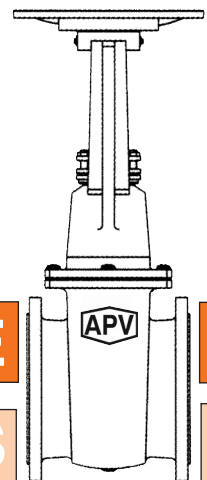

AUSTRALIAN PIPELINE VALVE



MATERIAL RANGE

CARBON STEEL

A216 WCB

A352 LCB

ALLOY STEEL

A217 WC6

A217 WC9

A217 C5

A217 C12

STAINLESS STEEL

A351 CF3M

A351 CF8C

A351 CF8M







A351 CF8

FORGED EQUIVALENTS & ALL OTHER MATERIALS AVAILABLE

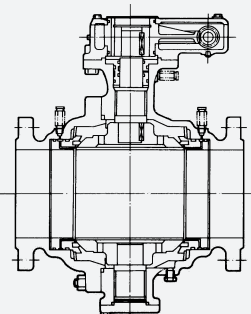

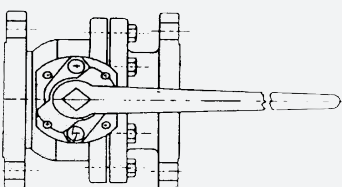
BALL VALVES

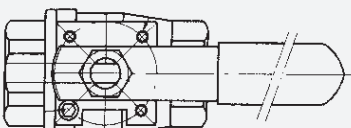

TYPE	CLASS	SIZES
 <p>2P & 3P TRUNNION (FORGED & CAST)</p> 	150 300 600 900 1500 2500 4500	ASME 1/2" - 36" 1/2" - 30" 1/2" - 28" 1/2" - 24" 1/2" - 20" 1/2" - 16" 2" - 4"
 <p>2P FLOATING</p> 	150 300 600 900 1500 2500	ASME 1/2" - 12" 1/2" - 10" 1/2" - 4" 1/2" - 2" 1/2" - 2" 1/2" - 1 1/2"
 <p>2P & 3P NPT & WELD END</p> 	800 1500 2500	ASME 1/2" - 4" 1/2" - 3" 1/2" - 3"

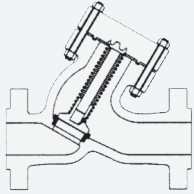
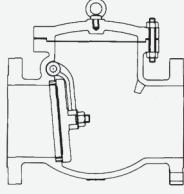
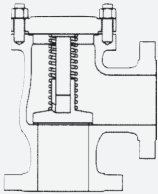
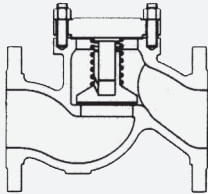
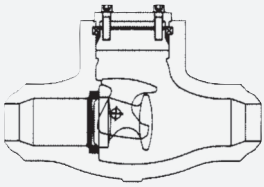
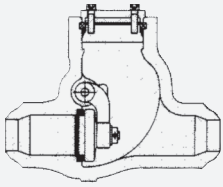
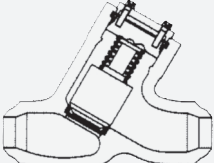
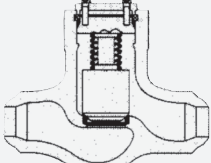

CHECK VALVES

TYPE	CLASS	SIZES	TYPE	CLASS	SIZES
PISTON Y TYPE 	150 300 600 900 1500 2500	ASME 2" - 24" 2" - 24" 2" - 14" 2" - 14" 2" - 12" 2" - 6"	SWING BOLTED BONNET 	150 300 600 900 1500 2500	ASME 2" - 48" 2" - 48" 2" - 40" 2" - 24" 2" - 24" 2" - 12"
PISTON 90° ANGLE 	150 300 600 900 1500 2500	ASME 1½" - 14" 1½" - 12" 2" - 10" 2" - 8" 2" - 6" 2" - 4"	PISTON 	150 300 600 900 1500	ASME 2" - 16" 2" - 16" 2" - 12" 2" - 12" 2" - 12"
TILTING DISC PRESSURE SEAL 	600 900 1500 2500	ASME 2" - 24" 2" - 24" 2" - 24" 2" - 12"	SWING PRESSURE SEAL 	600 900 1500 2500	ASME 2" - 24" 2" - 24" 2" - 24" 2" - 12"
LIFT PRESSURE SEAL Y TYPE 	600 900 1500 2500 4500	ASME 2" - 16" 2" - 16" 2" - 12" 2" - 12" 2" - 8"	LIFT PRESSURE SEAL STRAIGHT 	600 900 1500 2500 4500	ASME 2" - 16" 2" - 16" 2" - 12" 2" - 12" 2" - 8"

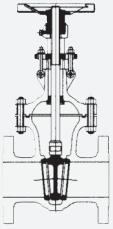
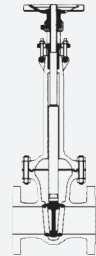
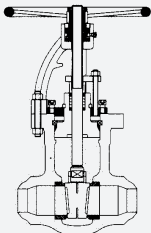
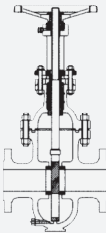
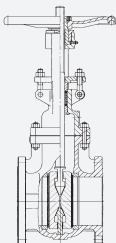

GATE VALVES

TYPE	CLASS	SIZES
	<p>BOLTED BONNET</p>	<p>ASME 150 2" - 48" 300 2" - 48" 600 2" - 40" 900 2" - 24" 1500 2" - 24" 2500 2" - 12"</p>
	<p>CROYGENIC EXTENDED BONNET</p>	<p>ASME 150 2" - 40" 300 2" - 40" 600 2" - 24" 900 2" - 24" 1500 2" - 24"</p>
	<p>BELLOW SEAL</p>	<p>ASME 150 2" - 24" 300 2" - 24" 600 2" - 24" 900 2" - 16" 1500 2" - 16"</p>
	<p>PRESSURE SEAL</p>	<p>ASME 600 2" - 24" 900 2" - 24" 1500 2" - 24" 2500 2" - 24" 4500 2" - 8"</p>
	<p>THROUGH CONDUIT</p>	<p>ASME 150 2" - 40" 300 2" - 40" 600 2" - 40" 900 2" - 24" 1500 2" - 24"</p>
	<p>PARALLEL SLIDE</p>	<p>ASME+BS 150 2" - 40" 300 1/2" - 36" 600 1/2" - 30" 900 1/2" - 26" 1500 1/2" - 24"</p>

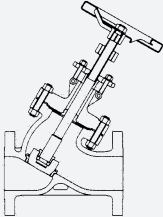

GLOBE VALVES

TYPE	CLASS	SIZES
Y TYPE 		ASME
	150	2" - 16"
	300	2" - 16"
	600	2" - 16"
	900	2" - 12"
	1500	2" - 12"

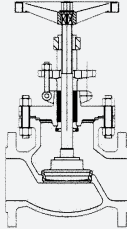
TYPE	CLASS	SIZES
BOLTED BONNET 		ASME
	150	2" - 16"
	300	2" - 16"
	600	2" - 16"
	900	2" - 12"
	1500	2" - 12"

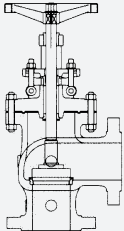
TYPE	CLASS	SIZES
ANGLE 90° 		ASME
	150	2" - 16"
	300	2" - 16"
	600	2" - 16"
	900	2" - 12"
	1500	2" - 12"

TYPE	CLASS	SIZES
CRYOGENIC 		ASME
	150	2" - 16"
	300	2" - 16"
	600	2" - 16"
	900	2" - 12"
	1500	2" - 12"

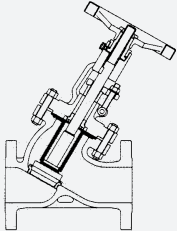
TYPE	CLASS	SIZES
BELLOW SEAL Y TYPE 		ASME
	150	2" - 16"
	300	2" - 16"
	600	2" - 16"
	900	2" - 12"
	1500	2" - 12"

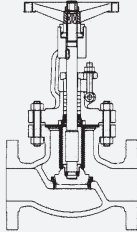
TYPE	CLASS	SIZES
BELLOW SEAL 		ASME
	150	2" - 16"
	300	2" - 16"
	600	2" - 16"
	900	2" - 12"
	1500	2" - 12"

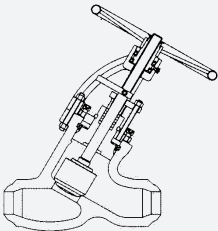
TYPE	CLASS	SIZES
PRESSURE SEAL Y TYPE 		ASME
	600	2" - 16"
	900	2" - 16"
	1500	2" - 12"
	2500	2" - 12"
	4500	2" - 8"

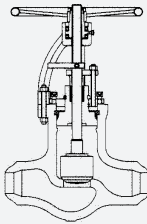
TYPE	CLASS	SIZES
PRESSURE SEAL 		ASME
	600	2" - 16"
	900	2" - 16"
	1500	2" - 12"
	2500	2" - 12"
	4500	2" - 8"



PLUG VALVES



TYPE	CLASS	SIZES
	LUBRICATED DYNAMIC PRESSURE BALANCE INVERTED PLUG FIRESAFE  <small>Firesafe Certified API 607 5th Edition, API 6FA 3rd Edition</small>	ASME 1" - 20" 1" - 20" 1/2" - 18" 1/2" - 12" 1/2" - 10" 1/2" - 8"
	150 300 600 900 1500 2500	

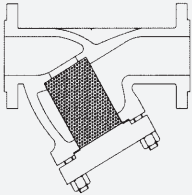
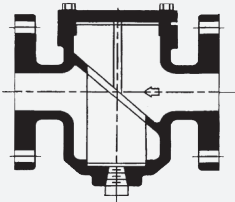

STRAINERS

TYPE	CLASS	SIZES	TYPE	CLASS	SIZES
Y TYPE 	150 300 600 900 1500 2500	ASME 2" - 24" 2" - 24" 2" - 24" 2" - 16" 2" - 16" 2" - 8"	BASKET TYPE 	150 300 600 900 1500 2500	ASME 2" - 14" 2" - 12" 2" - 10" 2" - 8" 2" - 6" 2" - 4"

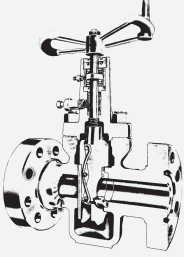
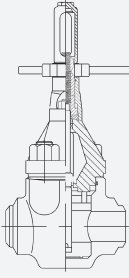
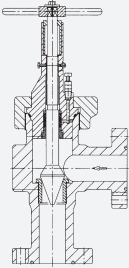
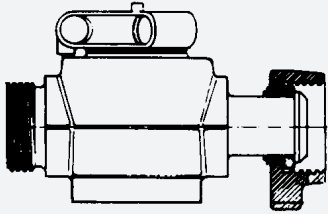

OILFIELD PRODUCTS

TYPE	RATING	SIZES	TYPE	RATING	SIZES
API6A SLAB/EXPANDING GATE 	3000 PSI 5000 PSI 10,000 PSI	API 2 ¹ / ₁₆ " - 7 ¹ / ₁₆ " 2 ¹ / ₁₆ " - 7 ¹ / ₁₆ " 1 ¹³ / ₁₆ " - 4 ¹ / ₁₆ "	API6A MUD GATE VALVE TYPE 'DM' 	3000 PSI 5000 PSI	API 2 ¹ / ₁₆ " - 4 ¹ / ₁₆ " 2 ¹ / ₁₆ " - 4 ¹ / ₁₆ "
CHOKES H2 RIGHT ANGLE 	3000 PSI 5000 PSI	API 2 ¹ / ₁₆ " - 4 ¹ / ₁₆ " 2 ¹ / ₁₆ " - 4 ¹ / ₁₆ "	PLUG VALVES OILFIELD TYPE SPM STYLE WECO ENDS 	3000 PSI 5000 PSI 10000 PSI 15000 PSI	API 1" - 4" 1" - 4" 2" - 4" 2" - 4"

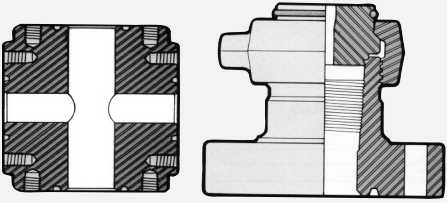
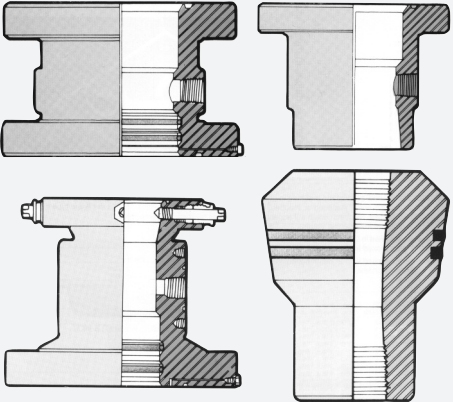
TYPE	RATING	SIZES
 CROSSES, TEES, TREE CAPS, COMPLETE TREES	3000 PSI 5000 PSI 10000 PSI	2 ¹ / ₁₆ " - 7 ¹ / ₁₆ " 2 ¹ / ₁₆ " - 7 ¹ / ₁₆ " 1 ¹³ / ₁₆ " - 4 ¹ / ₁₆ "
 WELLHEADS:- CASING HEADS CASING SPOOLS TUBING SPOOLS CASING SLIPS TUBING HANGERS ALL AVAILABLE FMC OR CIW COMPATIBLE	3000 PSI 5000 PSI 10000 PSI	7 ¹ / ₁₆ " - 20 ³ / ₄ " 7 ¹ / ₁₆ " - 16 ³ / ₄ " 7 ¹ / ₁₆ " - 13 ⁵ / ₈ "



FAMILY OF BRANDS

Australian Pipeline Valve (APV) manufacturers a complete range of ASME, API & BS/AS valves such as check, gate, globe, as well as firesafe certified ball and plug valves for petrochemical, oil, gas, mining, process and industrial markets under the Australian Pipeline Valve brand. Australian Pipeline Valve also supply oilfield wellheads and associated products.

The Australian Pipeline Valve family also includes the following brands which cover a broad range of valve types and pipeline products for all industries:

APV-Diamond Gear®	1/4 turn worm gearboxes, declutchable gear boxes, multi-turn bevel gearboxes
APV-Flowturn®	Iron diaphragm, gate, globe, check valves, multi-way ball valves, deadman ball valves, needle valves, sight glasses, strainers.
APV-Steamco®	Steam valves: parallel slide, stop check (SDNR), right angle globe.
APV-Supercheck®	Dual & single flap wafer check valves.
APV-Superseal®	High performance and lined butterfly valves for all industries including oil, gas, chemical etc. Also iron and steel ball valves for industrial markets.
APV-Torqturn®	Pneumatic & hydraulic heavy duty piston actuators to suit pipeline valves for oil & gas installations. Scotch yoke, rack & pinion, all sizes, up to very high torque range.
APV-Uniflo®	Cast iron & Rubber flap check valves.
APV-Twinlok®	Twin ferrule stainless steel tube compression fittings fully interchangeable with major brands.



TWIN-LOK



STEAMCO®

UNIFLO™

SUPERSEAL®

SUPER-CHECK™

TORQTURN